



## READY<sup>®</sup> CHAIRS & STOOLS

Available in 6 different base styles, & multiple sizes. Ready Chairs are ideal for classrooms, maker spaces, libraries & for students & teachers alike.

## HOW TO SPECIFY

### FRAME

Constructed with 1" diameter 11-gauge tubular steel, supported by 14-gauge steel brackets. 360° contact points between underside steel frame & shell with steel rivets for advanced durability. Frame finished with electrostatically charged powder coating.

### SHELL

Gas-assist injection-molded polypropylene one-piece shell with deep chamfered edge & flexible back. Chair back allows for 18° of pressure flex, is smooth without ribs, & has single opening contoured handle cut-out. Chair seat includes ComfortSlope™ chamfered edge & allows for convenient 4-way sit. Available in 16 colors.

### GLIDES

4 leg chairs, stools, & cantilever chairs all come standard with steel-encased nylon-base glides for safe & easy movement. These style chairs can also be specified with felt or metal base glides depending on flooring material.

### CERTIFICATIONS

- ANSI/BIFMA X6.1 Safety & performance standards for educational seating.
- MAS certified green.
- LEED for schools CHPS EQ 2.3.5 credit.



### CHAIR SIZE GUIDE

Seat Height	14"	16"	18"
1 <sup>st</sup> Grade	X		
2 <sup>nd</sup> Grade	X	X	
3 <sup>rd</sup> Grade		X	
4 <sup>th</sup> Grade		X	
5 <sup>th</sup> Grade			X
6 <sup>th</sup> - 12 <sup>th</sup> Grade			X



Cantilever

Caster

Cafe Stool

Lab Stool

Task

## CONFIGURING A MODEL NUMBER

Choose your family part. Refer to the price list for a list of READY Chair models. In this example, we used part **READY4L18-BT-BN**. The structure of this new part number can be broken up with parenthesis like this:

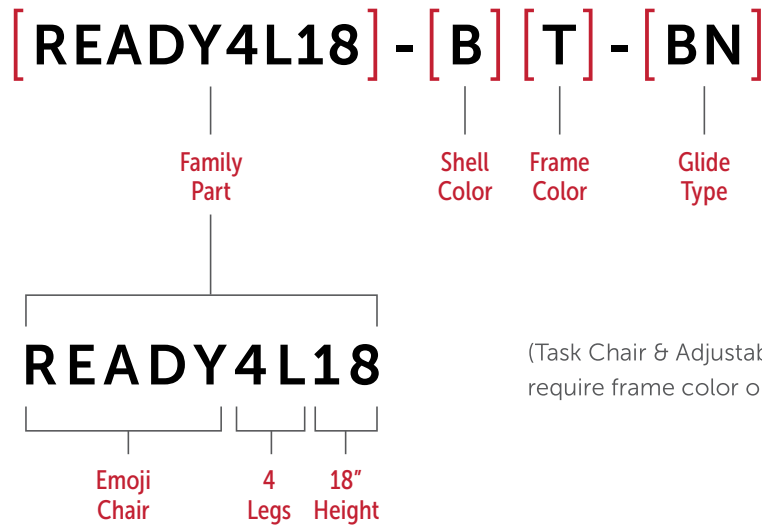

## COLOR & FINISH OPTIONS

### STEP 1 SHELL COLOR

Use the letter next to the Family part as the key code for **STEP 1**

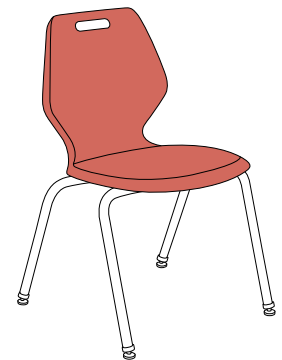

**[ FAMILY PART ] - [ SHELL COLOR ]**

FIRE TRUCK RED (A)	VANILLA BLUE (E)	PURPLE (P)	BLUESCAPE (U)
BLACK (B)	GRASS GREEN (I)	GREEN BEAN (Q)	ORANGESICLE (X)
MOD NAVY (C)	GRAPHITE (M)	GRAPLE (R)	LELLO (Y)
COFFEE (D)	COOL GRAY (O)	TANG (S)	WISDOM (Z)

## STEP 2 FRAME

Choose your frame color. Refer to the letter next to the color name for **STEP 2**



[ FAMILY ] - [ SHELL ] [ FRAME ]  
[ PART ] - [ COLOR ] [ COLOR ]



BLACK  
(B)



TITANIUM  
(T)



WISDOM  
(Z)



FLANNEL  
(F)



COOL GRAY  
(O)

## STEP 3 GLIDE

Chairs come standard with nylon glides. For metal glides, add BM to the end of the model number. For felt glides, add BF to the end of the model number. If not specified, chair will have nylon glides.

[ FAMILY ] - [ SHELL ] [ FRAME ] - [ GLIDE ]  
[ PART ] - [ COLOR ] [ COLOR ] - [ TYPE ]

	Carpet Floor	Hardwood Floor	Bamboo Floor	Rubber Floor	Concrete Floor	Tile Floor	VCT Floor	Laminate Floor
Nylon Glide	X			X	X	X	X	
Metal Glide (BM)	X							
Felt Glide (BF)		X	X			X	X	X

**MODEL NUMBERS & PRODUCT SPECS**

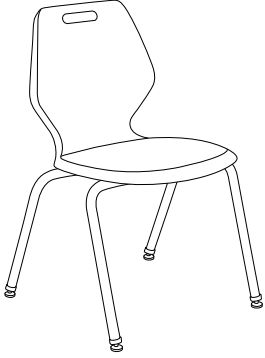

**READY® 4-LEG CHAIR**

Model #	Seat Height (in)	Width (in)	Depth (in)	Weight Capacity (lbs)	Overall Height (in)	Weight (lbs)	Freight Class (Qty 1)
READY4L14	14.2	18.1	16.4	175	25.6	10	200
READY4L16	16.2	18.1	18	230	27.6	10	200
READY4L18	18.1	20.7	19.4	330	31.7	15	200

\*Add **BM** for Metal glides or **BF** for Felt glides. No price increase. Ex: READY4L14**BM** / READY4L14**BF**

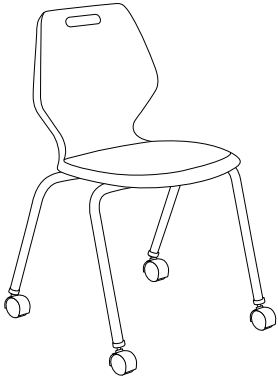

**READY® 4-LEG WITH CASTERS**

Model #	Seat Height (in)	Width (in)	Depth (in)	Weight Capacity (lbs)	Overall Height (in)	Weight (lbs)	Freight Class (Qty 1)
READY4L14C	14.3	18.3	15.9	175	25.7	10	200
READY4L16C	16.1	18.3	17.1	230	27.5	10	200
READY4L18C	18	20.9	18.5	300	31.6	15	200

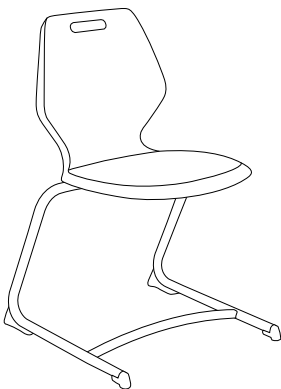

**READY® CANTILEVER CHAIR**

Model #	Seat Height (in)	Width (in)	Depth (in)	Weight Capacity (lbs)	Overall Height (in)	Weight (lbs)	Freight Class (Qty 1)
READYCA14	14	17.9	14.6	175	25.4	10	200
READYCA16	16	17.9	14.6	230	27.4	15	200
READYCA18	18	20.4	18.4	300	31.6	20	200

\*Add **BM** for Metal glides or **BF** for Felt glides. No price increase. Ex: READYCA14**BM** / READYCA14**BF**

## READY® 4-LEG STOOL

Model #	Seat Height (in)	Width (in)	Depth (in)	Weight Capacity (lbs)	Overall Height (in)	Weight (lbs)	Freight Class (Qty 1)
READY4LST25	25	18.2	19.1	300	38.6	20	200
READY4LST30	30.4	18.2	20.9	300	44	20	200

\*Add **BM** for Metal glides or **BF** for Felt glides. No price increase. Ex: READY4LST25BM / READY4LST25BF

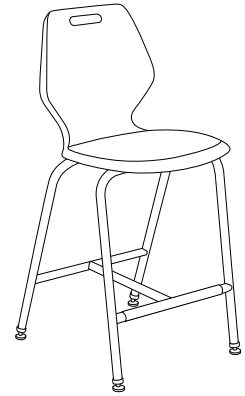

## READY® TASK CHAIR

Model #	Seat Height (in)	Width (in)	Depth (in)	Weight Capacity (lbs)	Overall Height (in)	Weight (lbs)	Freight Class (Qty 1)
READYCHRA	17 - 23	24	24	300	30.6 - 36.6	20	200

\*Available with black frame only

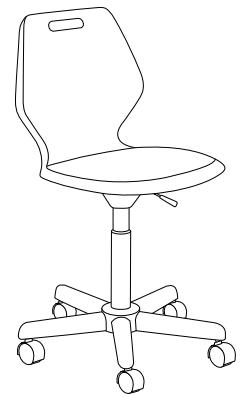

## READY® LAB STOOL

Model #	Seat Height (in)	Width (in)	Depth (in)	Weight Capacity (lbs)	Overall Height (in)	Weight (lbs)	Freight Class (Qty 1)
READYSTLA	22.5 - 32.5	24	24	300	36.2 - 46.2	20	200

\*Available with black frame only

